

SANUS SYSTEMS

THE UNION OF FORM AND FUNCTION

Assembly Instructions for Television Turntables™ TV13, TV20, TV27, TV32

Congratulations on your purchase! Sanus Systems Television Turntables™ are functional, attractive, and inexpensive. They are finished with a black powder that is both durable and beautiful. Please check carefully to make sure there are no missing or defective parts. Never use defective parts. Improper assembly may cause damage or injury. If you do not understand these directions, or have any questions about this assembly please contact Sanus at 800.359.5520 or www.sanus.com. We can quickly assist you with installation questions and missing or damaged parts.

Supplied Parts: (1) Television Turntable

Supplied Parts: (1) Self Adhesive Protective Feet (pad of 4)

Step 1:

Position the Turntable so the black nylon swivel is facing up. Locate the circles at the end of each spoke. Next, place a Adhesive Foot inside each circle, as shown in Diagram 1.

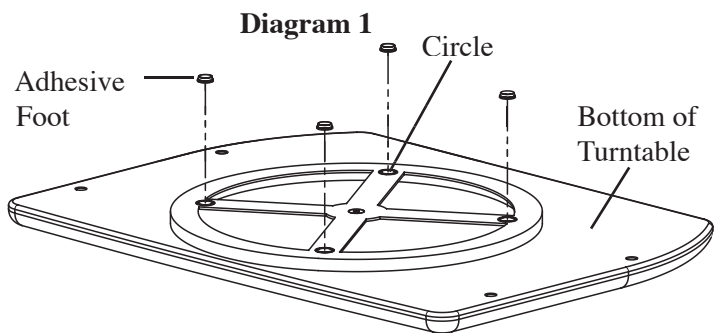

NOTE: If you are going to use the optional TV-VCR Kit, Proceed to the instructions for those at the bottom of the page, otherwise, proceed to Step 2.

Step 2:

Flip the Turntable over and place it in the desired position on a shelf or cabinet so the Adhesive Feet are facing down and are in direct contact with the shelf or cabinet as shown in Diagram 2.

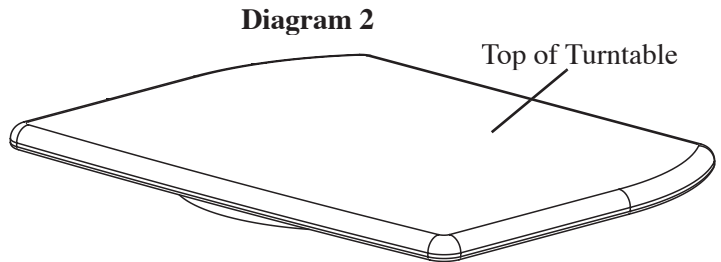

Assembly Instructions for Optional TV-VCR Kit*

*TV-VCR Kit will not work with the TV13 Turntable

- Contents:** (1) Base
(2) Support Pillars
(4) Plastic Dowels
(4) Allen bolts
(1) Allen Wrench

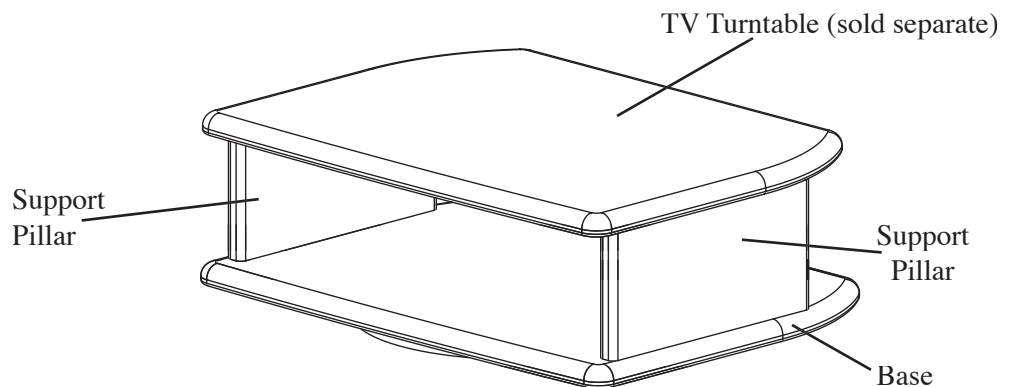

Step 1:

Remove the swivel from the TV Turntable by removing the Phillips Screw in the center of the swivel as shown in the Diagram to the right.

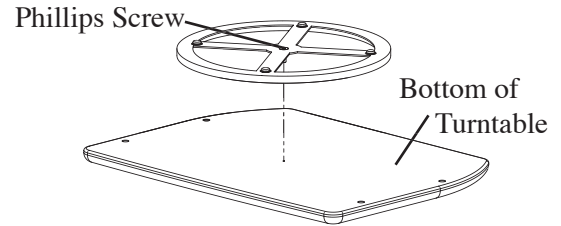

Step 2:

Use the same Phillips Screw removed from Step 1 to fasten the swivel to the base of the TV-VCR Kit. Insert the Phillips screw through the center hole of the swivel and proceed to thread it into the appropriate pilot hole in the center of the TV-VCR Kit as shown in the Diagram on the right. Tighten the Phillips Screw with a phillips screw driver until tight.

NOTE: When using the TV20 use the front Pilot Hole. When Using the TV27 or TV32 use the rear Pilot Hole.

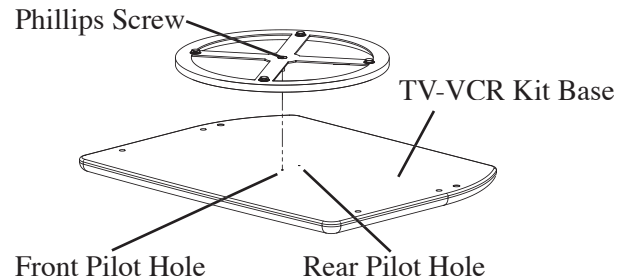

Step 3:

Insert the Plastic Dowels into the larger holes in the Support Pillar as shown in the Diagram on the right. Gently tap the Plastic Dowels in with a hammer if needed. Repeat step for the other Support Pillar.

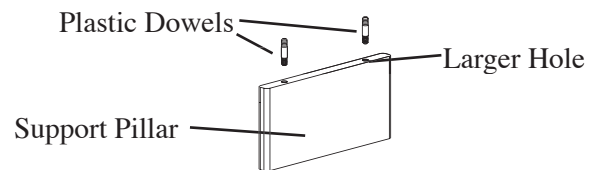

Step 4:

Thread the Allen Bolts up through the Base of the TV-VCR Kit, and into the corresponding holes in the Support Pillar. Tighten Allen Bolts with the provided Allen Key until they are tight.

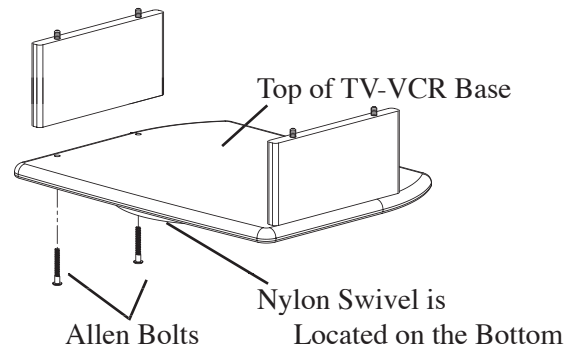

Step 5:

Add the TV Turntable to the TV-VCR Kit by setting the Turntable on top of the Support Pillars so the dowels in the Support Pillars line up with the holes in the bottom side of the turntable. Press the Turntable down firmly until the bottom of the Turntable is flush with the top of the Support Pillars.

